

## MELODY-4-S

~12° spot beam with 3 optics

### TECHNICAL SPECIFICATIONS:

Dimensions	Ø 50.6 mm
Height	11.9 mm
Fastening	pin
Colour	clear
Box size	480 x 280 x 300 mm
Box weight	5.8 kg
Quantity in Box	364 pcs
ROHS compliant	yes ⓘ



### MATERIAL SPECIFICATIONS:

Component	Type	Material	Colour
MELODY-4-S	Lens	PMMA	clear

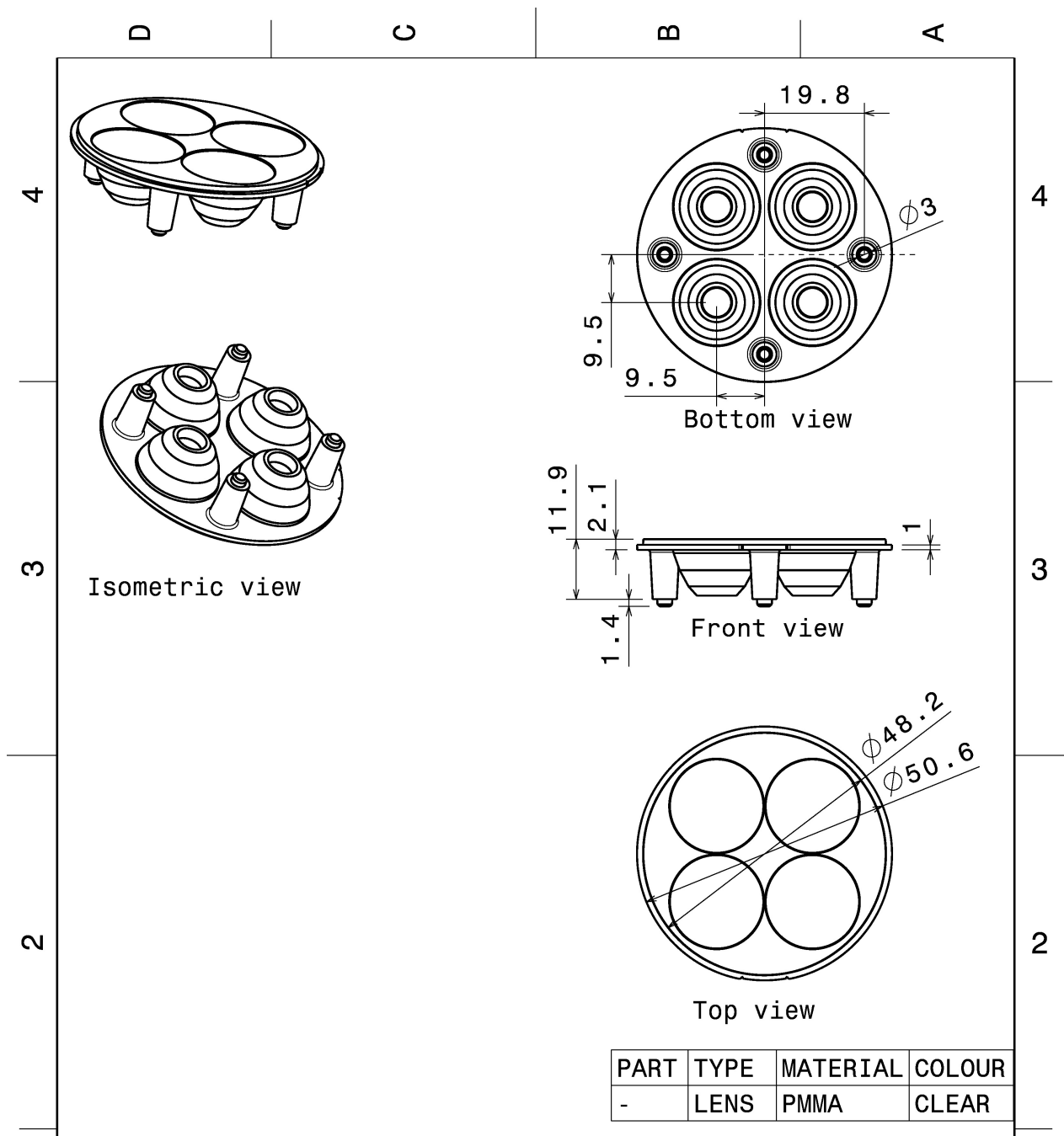

PART	TYPE	MATERIAL	COLOUR
-	LENS	PMMA	CLEAR

This drawing is our property. It can't be reproduced or communicated without our written agreement.

**LEDiL**  
A WORLD OF INNOVATION  
Ledil Oy  
Joensuunkatu 13  
FIN 24100 SALO  
Finland

DRAWN BY mav		DATE 18.04.2012	DRAWING TITLE <b>Datasheet MELODY-4 series</b>			
CHECKED BY sn	DATE 18.04.2012	SIZE <b>A4</b>	DRAWING NUMBER -			REV <b>1</b>
DESIGNED BY mav	DATE 06.03.2012	SCALE 1:1	WEIGHT (g)		SHEET 1/1	

#### PHOTOMETRIC DATA (MEASURED):



LED XP-E  
 FWHM 8.0°  
 Efficiency 90 %  
 Peak intensity 29.900 cd/Im  
 Required components:

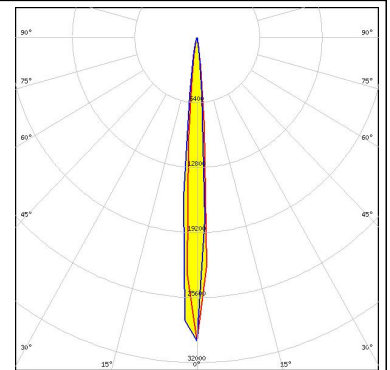
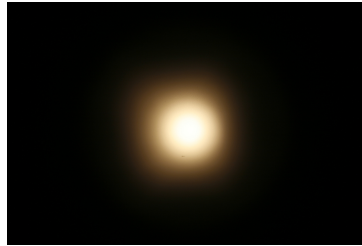

LED XP-E2  
 FWHM 9.0°  
 Efficiency 92 %  
 Peak intensity 28.500 cd/Im  
 Required components:

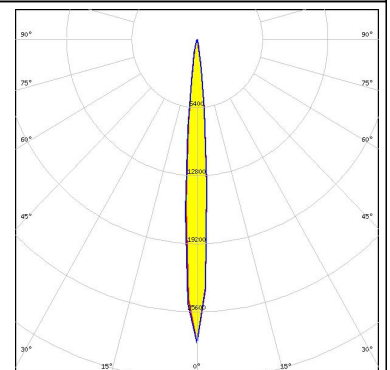

LED XP-G  
 FWHM 12.0°  
 Efficiency 89 %  
 Peak intensity 14.800 cd/Im  
 Required components:

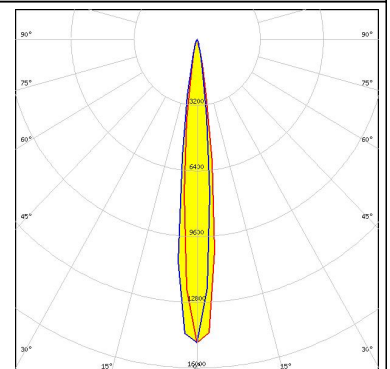

LED XP-G2  
 FWHM 12.0°  
 Efficiency 92 %  
 Peak intensity 16.600 cd/Im  
 Required components:

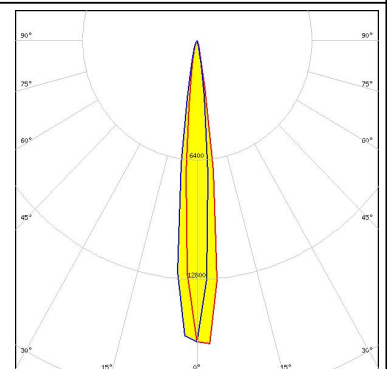

#### PHOTOMETRIC DATA (MEASURED):



LED XT-E  
 FWHM 12.0°  
 Efficiency 90 %  
 Peak intensity 15.800 cd/lm  
 Required components:

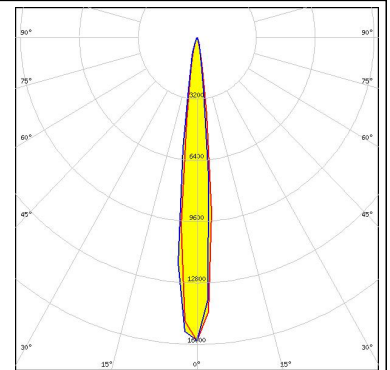
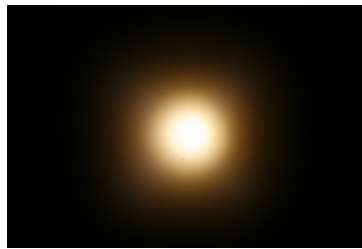

LED LUXEON A  
 FWHM 13.0°  
 Efficiency 91 %  
 Peak intensity 14.600 cd/lm  
 Required components:

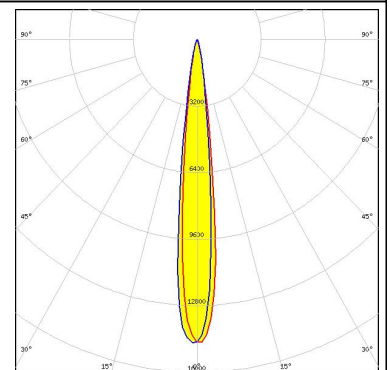

LED LUXEON Rebel  
 FWHM 11.0°  
 Efficiency 91 %  
 Peak intensity 19.900 cd/lm  
 Required components:

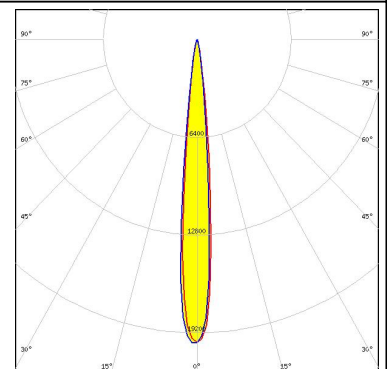
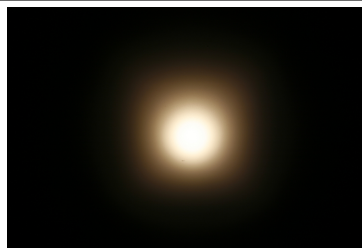

LED LUXEON Rebel ES  
 FWHM 13.0°  
 Efficiency 91 %  
 Peak intensity 14.800 cd/lm  
 Required components:

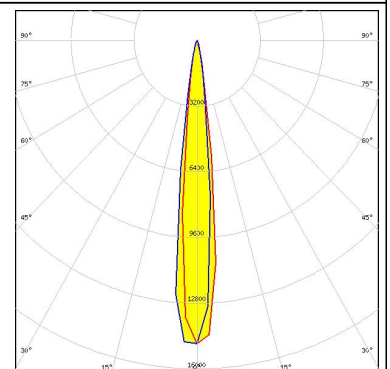

#### PHOTOMETRIC DATA (MEASURED):



LED LUXEON Z ES  
 FWHM 9.0°  
 Efficiency 91 %  
 Peak intensity 31.400 cd/lm  
 Required components:

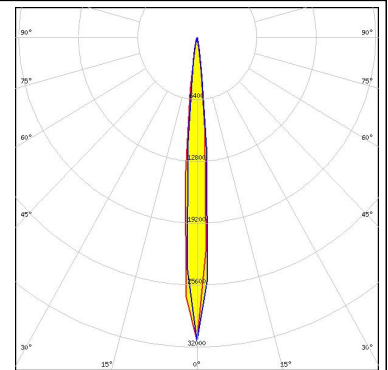

LED NCSxx19A  
 FWHM 9.0°  
 Efficiency 88 %  
 Peak intensity 21.700 cd/lm  
 Required components:

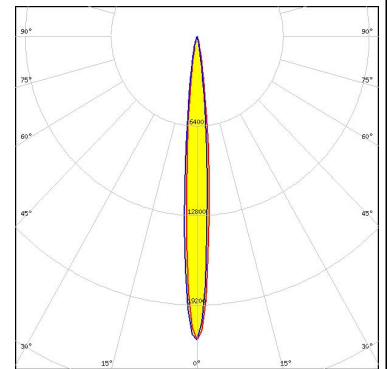

LED NCSxx19B  
 FWHM 11.0°  
 Efficiency 89 %  
 Peak intensity 21.600 cd/lm  
 Required components:

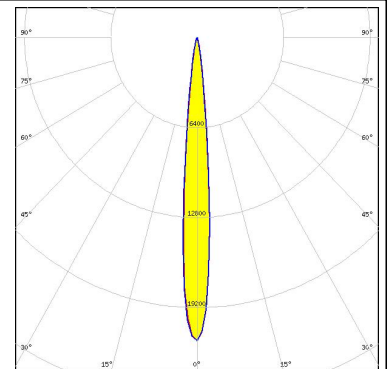

LED NVSxx19A  
 FWHM 13.0°  
 Efficiency 88 %  
 Peak intensity 13.700 cd/lm  
 Required components:

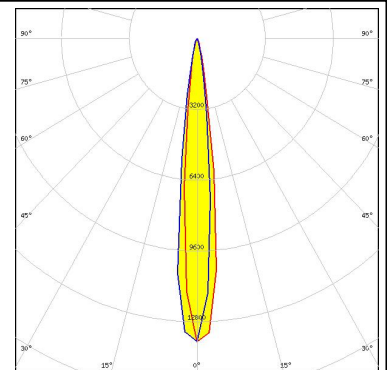

#### PHOTOMETRIC DATA (MEASURED):



LED NVSxx19B/NVSxx19C  
FWHM 14.0°  
Efficiency 90 %  
Peak intensity 12.900 cd/lm  
Required components:

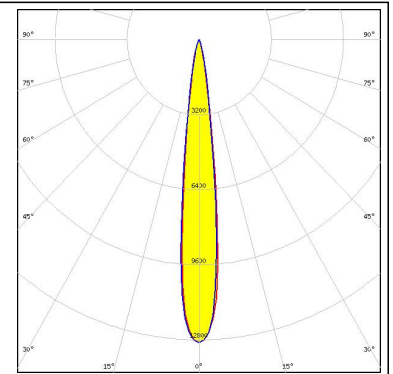
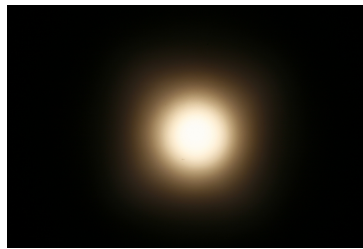

#### GENERAL INFORMATION:

NOTE: The typical beam angle will be changed by different color, chip size and chip position tolerance. The typical total beam angle is the full angle measured where the luminous intensity is half of the peak value.

#### MATERIALS:

As part of our continuous research and improvement processes, and to ensure the best possible quality and availability of our products, LEDiL reserves the right to change material grades without notice.

#### PRODUCT DATA USER AGREEMENT AND DISCLAIMER:

The measured data in the provided downloadable LEDiL Product Datasheets and Mechanical 2D-Drawings is rounded and provided as reference for planning. LEDiL Oy's optical specifications have been verified by conducting performance testing of the products in accordance with the company's quality system. The reported data are averaged results of multiple measurements with typical variation. LEDiL Oy reserves the right to without prior notification make changes and improvements to its products.

LEDiL Oy assumes neither warranty, nor guarantee nor any other liability of any kind for the contents and correctness of the provided data. The provided data has been generated with highest diligence but the provided data may in reality not represent the complete possible variation range of all intrinsic parameters. Therefore, in certain cases a deviation from the provided data could occur.

LEDiL Oy reserves the right to undertake technical changes of its products without further notification which could lead to changes in the provided data. LEDiL Oy assumes no liability of any kind for the possible deviation from any provided data or any other damage resulting from the usage of the provided data.

The user agrees to this disclaimer and user agreement with the download or usage of the provided files.

#### LEDiL Oy

Joensuunkatu 13  
FI-24240 SALO  
Finland

#### LEDiL Inc.

228 West Page Street  
Suite D  
Sycamore IL 60178  
USA

#### Local sales and technical support

[www.ledil.com/  
where\\_to\\_buy](http://www.ledil.com/where_to_buy)

#### Shipping locations

Salo, Finland  
Hong Kong, China

#### Distribution Partners

[www.ledil.com/  
where\\_to\\_buy](http://www.ledil.com/where_to_buy)